

SmartSet[®] CD Clock Radio
with Automatic Time Setting System
Digital Tuning Stereo Receiver
and Touchless Snooze Control

OWNER'S MANUAL

CKD5809



(U.S. Patent No. 6,567,344)

Visit our web site at www.emersonradio.com



CAUTION

TO PREVENT FIRE OR SHOCK HAZARD, DO NOT USE THIS PLUG WITH AN EXTENSION CORD, RECEPTACLE OR OTHER OUTLET UNLESS THE BLADES CAN BE FULLY INSERTED TO PREVENT BLADE EXPOSURE. TO PREVENT FIRE OR SHOCK HAZARD, DO NOT EXPOSE THIS APPLIANCE TO RAIN OR MOISTURE.

 <p>The lightning flash with arrow-head symbol, within an equilateral triangle is intended to alert the user to the presence of uninsulated 'dangerous voltage' within the product's enclosure that may be of sufficient magnitude to constitute a risk of electric shock to persons.</p>	<p style="text-align: center;">CAUTION</p> <p style="text-align: center;">RISK OF ELECTRIC SHOCK DO NOT OPEN</p> <p>WARNING: TO REDUCE THE RISK OF ELECTRIC SHOCK DO NOT REMOVE COVER (OR BACK), NO USER SERVICEABLE PARTS INSIDE REFER SERVICING TO QUALIFIED SERVICE PERSONNEL.</p>	 <p>The exclamation point within an equilateral triangle is intended to alert the user to the presence of important operating and maintenance (servicing) instructions in the literature accompanying the appliance.</p>
--	---	---

The Caution Marking maybe located at the bottom enclosure of the apparatus.

IMPORTANT SAFETY INSTRUCTIONS

- 1.) Read these instructions. Keep these instructions. Follow all instructions. Heed all warnings.
- 2.) Do not use this apparatus near water.
- 3.) Clean only with dry cloth.
- 4.) Do not block any ventilation openings. Install in accordance with the manufacturer's instructions.
- 5.) Do not install near any heat sources such as radiators, heat registers, stoves, or other apparatus (including amplifiers) that produce heat.
- 6.) Do not defeat the safety purpose of the polarized or grounding-type plug. A polarized plug has two blades with one wider than the other. A grounding type plug has two blades and a third grounding prong. The wide blade or the third prong is provided for your safety. If the provided plug does not fit into your outlet, consult an electrician for replacement of the obsolete outlet.
- 7.) Protect the power cord from being walked on or pinched particularly at plugs, convenience receptacles, and the point where they exit from the apparatus.
- 8.) Only use attachments / accessories specified by the manufacturer.
- 9.) Unplug this apparatus during lightning storms or when unused for long periods of time.
- 10.) Refer all servicing to qualified service personnel. Servicing is required when the apparatus has been damaged in any way, such as power-supply cord or plug is damaged, liquid has been spilled or objects have fallen into the apparatus, the apparatus has been exposed to rain or moisture, does not operate normally, or has been dropped.
- 11.) This appliance shall not be exposed to dripping or splashing water and no object filled with liquids such as vases shall be placed on the apparatus.
- 12.) Use only with the cart, stand, tripod, bracket, or table specified by the manufacturer, or sold with the apparatus. When a cart is used, use caution when moving the cart/apparatus combination to avoid injury from tip-over.
- 13.) Do not overload wall outlet. Use only power source as indicated.
- 14.) Use replacement parts as specified by the manufacturer.
- 15.) The product may be mounted to a wall only if recommended by the manufacturer.
- 16.) Upon completion of any service or repairs to this product, ask the service technician to perform safety checks.





Thank You.....

For purchasing this Emerson Research Stereo CD Clock Radio with the patented SmartSet® automatic time setting system. As soon as you plug-in your radio for the first time, and after every power interruption, the clock will automatically set itself to the correct, year, month, date, day, and time. It will also automatically adjust itself for all Daylight Saving Time changes, through the year 2099.

There are dual alarms that can be set and used independently. The alarms can be set for weekdays only, weekends only or everyday operation. You can wake to an electronic buzzer tone, your favorite AM or FM station or a specific track on your favorite CD. And if you can't reach the snooze bar when the alarm goes off you can just wave you hand in front of the "Touchless" snooze sensor on the front panel. The alarm will shut off for 9 minutes and then turn on again. There's a programmable 99-minute sleep timer that allows you to fall asleep to up to 99 minutes of music and then shuts the power off automatically.

A programmable 99-minute nap timer lets you wake up after a nap without disturbing your normal alarm settings.

The CD player has a 20-track programmable memory and repeat playback. It will also play CD-R and CD-RW discs in addition to normal CDs. The digital tuning stereo receiver locks in your favorite stations perfectly and stores up to 20 stations (10 AM and 10 FM) in memory for immediate recall.

This model also includes a dual battery back up system. There's a built in CR2430 lithium battery that will maintain the time and alarm settings for up to 5 years or longer, depending on the frequency and length of the power interruptions you experience in your home. We've also provided a Sure Alarm battery back up system that will activate the alarm even if the power of off at your wake up time. The Sure Alarm circuit requires a 9-Volt battery, not included.

The time, radio frequency, and CD track number all appear on a large super bright LED display that is easily readable from anywhere in your room. And of course we've included a dimmer switch in case you want to reduce the display brightness for sleeping.

With so many useful features packed into such a compact unit it's imperative that you read this Owner's Manual carefully and completely.



We have taken great care to make sure that this unit was in perfect working order when it left our factory. If you have any problems with the set-up or operation of this model please do not return it to the dealer. Please call the Emerson Consumer Products Customer Service Hotline, toll-free at: 1-800-898-9020. One of our customer service representatives will try to diagnose and correct the problem for you. If we cannot solve the problem by phone you will be instructed how to receive a replacement unit.

Once again, all of us at Emerson Radio thank you for your purchase.



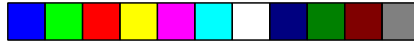

IMPORTANT NOTES

- Avoid installing this unit in places exposed to direct sunlight or close to heat radiating appliances such as electric heaters, on top of other stereo equipment that radiates too much heat, places lacking ventilation or dusty areas, places subject to constant vibration and/ or humid or moist areas.
- Do not attempt to clean this unit with chemical solvents as this might damage the finish. Use a clean dry cloth.
- Operate controls and switches as described in the manual.
- Before turning 'On' the power, make certain that power cord is properly installed.
- Store your CDs in a cool area to avoid damage from heat.
- When moving the set, be sure to first disconnect the power cord.

CLASS 1 LASER PRODUCT

CLASS 1 LASER PRODUCT APPAREIL À LASER DE CLASSE 1 PRODUCTO LASER DE CLASE 1	CAUTION INVISIBLE LASER RADIATION WHEN OPEN AND INTERLOCKS DEFEATED. AVOID EXPOSURE TO BEAM	
--	---	---

This product contains a low power Laser Device.

FCC Information

This equipment has been tested and found to comply with the limits for a Class B digital device, pursuant to Part 15 of the FCC Rules. These limits are designed to provide reasonable protection against harmful interference in a residential installation. This equipment generates, uses, and can radiate radio frequency energy and, if not installed and used in accordance with the instructions, may cause harmful interference to radio communications. However, there is no guarantee that interference will not occur in a particular installation. If this equipment does cause harmful interference to radio or television reception, which can be determined by turning the equipment off and on, the user is encouraged to try to correct the interference by one or more of the following measures:

- Reorient or relocate the receiving antenna.
- Increase the separation between the equipment and receiver.
- Connect the equipment into an outlet on a circuit different from that to which the receiver is connected.
- Consult the dealer or an experienced radio/TV technician for help.

This device complies with Part 15 of the FCC Rules. Operation is subject to the following two conditions:

- (1) This device may not cause harmful interference, and
- (2) This device must accept any interference received, including interference that may cause undesired operation.

Changes or modifications not expressly approved by the party responsible for compliance could void the user's authority to operate the equipment.

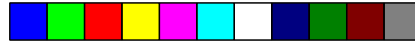

PREPARATION FOR USE

Unpacking and Set-up

- Remove the unit from the shipping carton and remove all packing material from the unit. Please save the carton and packing material if possible in the event that your unit ever needs to be returned for service. Using the original carton and packing materials is the only way to protect your unit from damage in transit.
- Carefully remove any small strips of tape that may have been used to keep the CD door closed during shipment.
- Press on the CD door in the area marked **OPEN/CLOSE** to open the door. Inside the CD compartment you will see a white “dummy CD” transit protection card. This card prevents the laser pick-up from moving during shipment and it must be removed before you can load your own CDs. Carefully remove this transit protection card and discard it.
- Place the unit on a stable, level surface such as a table, desk, shelf, stand, etc, out of direct sunlight and away from sources of excess heat, dust, vibration, moisture, or humidity, and convenient to a 120V 60Hz AC outlet.
- Unwind the AC power cord and extend it to its full length. This is important. The FM antenna is built into the AC power cord.

Battery Back-up Systems

This model has two separate battery back up systems. There is a built in 3-Volt **CR2430** long life lithium battery that will maintain the clock settings, the alarm settings and the tuner preset memory settings. The lithium battery may last for up to five years or even longer, depending on the frequency and length of the power interruptions that you experience in your home. If AC power is interrupted the display will go off but the lithium battery will continue to power the clock. When AC power is restored the display comes on again and all your settings are correct.

We have also provided a separate Sure-Alarm battery back up circuit that requires a 9-Volt battery, not included.

If you install a 9-Volt battery, the buzzer alarm will operate in BUZZER or RADIO mode, even if the power is off at the selected wake-up time.



Installing The Sure-Alarm Back-up Battery (Not Included)

The Sure-Alarm battery compartment is located on the back panel.

- 1.) Press down on the battery door locking tab as shown and remove the battery door.

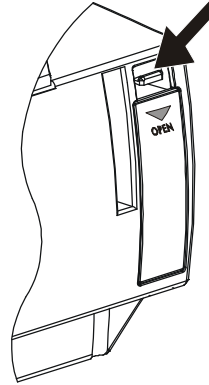

- 2.) Gently pull the battery terminal outside of the compartment just far enough so you can connect the battery.

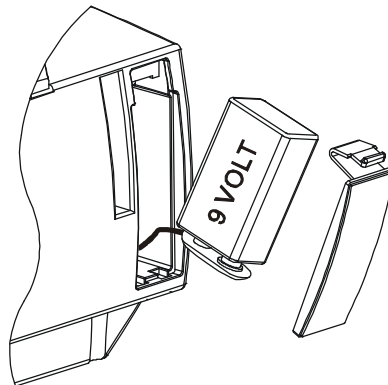

- 3.) Connect a fresh, well-known brand of 9-Volt Alkaline battery to the battery terminal. It can only be connected one way.

- 4.) Push the battery back into the battery compartment and replace the battery door.



Low Battery Indicator

The Low Battery indicator “LOW” only appears in the main display when the unit is in the power ‘Off’ mode.

- If you install a 9-Volt battery in the Sure Alarm circuit as described above, the Low Battery indicator disappears.
- If the Low Battery indicator remains ‘On’, this indicates that either you have not installed the 9-Volt battery, or that the 9-Volt battery is exhausted and needs to be replaced.
- If the Low Battery indicator flashes, this indicates that the 3-Volt lithium battery is getting weak and should be replaced as soon as possible.

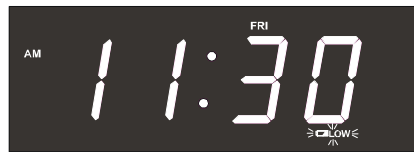
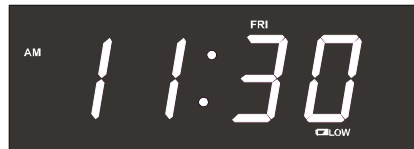
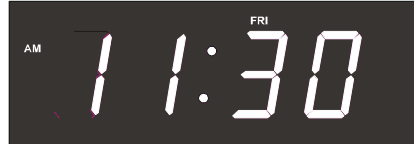

Instructions for changing the lithium battery will be found on page 32 of this manual.

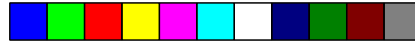

Power Source

This system is designed to operate on 120V AC 60Hz house current only. Connecting this system to any other power source may cause damage to the system and such damage is not covered by your warranty.

NOTE: The system has a polarized AC plug with one wide blade and one narrow blade. The plug will only fit into matching polarized AC outlets.

This is a safety feature to reduce the possibility of electric shock. If the plug will not fit in your AC outlet, you probably have an outdated non-polarized outlet. You should have your outdated outlet changed by a qualified, licensed electrician. Do not file the wide blade on the plug, or use an adapter to make the plug fit into your outlet. This defeats the safety feature and could expose you to electric shock.

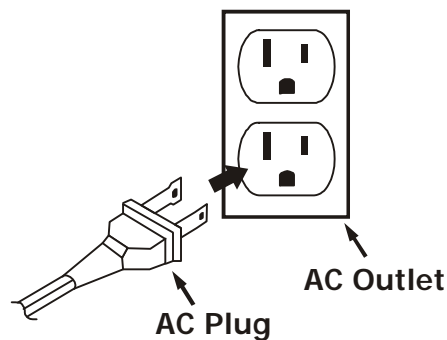

Protect Your Furniture

This model is equipped with non-skid rubber 'feet' to prevent the product from moving when you operate the controls. These 'feet' are made from non-migrating rubber material specially formulated to avoid leaving any marks or stains on your furniture. However certain types of oil based furniture polishes, wood preservatives, or cleaning sprays may cause the rubber 'feet' to soften, and leave marks or a rubber residue on the furniture. To prevent any damage to your furniture we strongly recommend that you purchase small self-adhesive felt pads, available at hardware stores and home improvement centers everywhere, and apply these pads to the bottom of the rubber 'feet' before you place the product on fine wooden furniture.

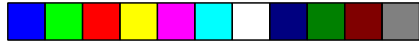

LOCATION OF CONTROLS AND INDICATORS

FRONT PANEL

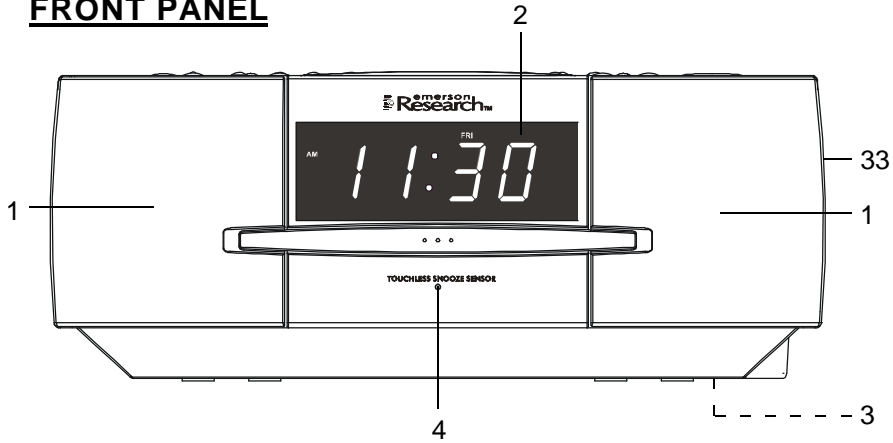

TOP PANEL

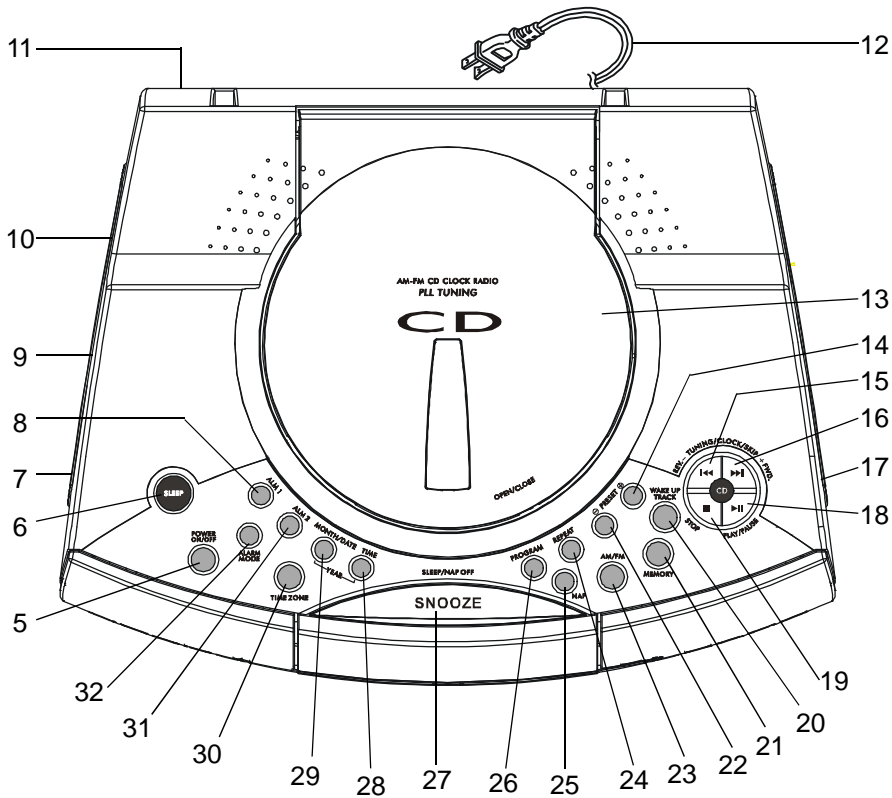



- 1.) Speakers.
- 2.) Multi-Function LED Display.
- 3.) 3-Volt Lithium Battery Compartment (Bottom Cabinet).
- 4.) **TOUCHLESS SNOOZE SENSOR.**
- 5.) **POWER ON/OFF** Button.
- 6.) **SLEEP** Button.
- 7.) **ALARM 1 (BUZZER/RADIO/CD/OFF)** Selector Switch.
- 8.) **ALM** (Alarm) 1 Button.
- 9.) **ALARM 2 (BUZZER/RADIO/CD/OFF)** Selector Switch.
- 10.) **DIMMER (LO/HI)** Selector Switch.
- 11.) 9-Volt Battery Compartment (Back Cabinet).
- 12.) AC Power Cord.
- 13.) CD Door.
- 14.) **PRESET +** Button.
- 15.) **◀◀ REV. SKIP/TUNING –** Button.
- 16.) **▶▶ FWD. SKIP/TUNING +** Button.
- 17.) **VOLUME** Control.
- 18.) **▶|| PLAY/PAUSE** Button.
- 19.) **■ STOP** Button.
- 20.) **WAKE UP TRACK** Button.
- 21.) **MEMORY** Button.
- 22.) **PRESET –** Button.
- 23.) **AM/FM** Button.
- 24.) **REPEAT** Button.
- 25.) **NAP** Button.
- 26.) **PROGRAM** Button.
- 27.) **SNOOZE/SLEEP/NAP OFF** Button.
- 28.) **TIME** Button.
- 29.) **MONTH/DATE** Button.
- 30.) **TIME ZONE** Button.
- 31.) **ALM** (Alarm) 2 Button.
- 32.) **ALARM MODE** Button.
- 33.) **🎧 PHONES** (Stereo Headphone) Jack.

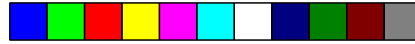

OPERATING INSTRUCTIONS

- Make sure that you have extended the AC power cord to its full length. The FM antenna is built into the power cord.
- Make sure that you have installed a fresh 9-Volt battery in the Sure Alarm circuit if you want the Sure Alarm battery back up circuit to operate. If you do not install a 9-Volt battery the Low Battery indicator will remain 'on', but this will not affect any other functions or operation of this product.
- Make sure that you have removed the "dummy CD" transit protection card from the CD compartment.

A Word About The ◀◀ And ▶▶ Controls

In order to minimize the number of controls on this model a few of the controls perform more than one function.

For example, the ◀◀ and ▶▶ buttons on the top panel perform the following functions:

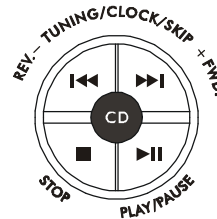

- When pressed together with the **TIME ZONE** button, the ◀◀ and ▶▶ buttons allow you to select a lower or higher numbered time zone.
- When pressed together with the **TIME** button, the ◀◀ and ▶▶ buttons adjust the time display backward or forward.
- When pressed together with the **ALM 1** or **ALM 2** buttons, the ◀◀ and ▶▶ buttons adjust the wake up time display backward or forward.
- When pressed together with the **MONTH/DATE** button, the ◀◀ and ▶▶ buttons adjust the Month and Date display backward or forward.
- When pressed together with the **TIME** and **MONTH/DATE** buttons, the ◀◀ and ▶▶ buttons adjust the year display backward or forward.
- When pressed together with the **SLEEP** or **NAP** buttons, the ◀◀ and ▶▶ buttons adjust the amount of Sleep Time or Nap Time display down or up.
- In Tuner mode (AM/FM) pressing the ◀◀ and ▶▶ buttons moves the tuner display down or up to lower or higher numbered frequencies.
- In CD mode pressing the ◀◀ and ▶▶ buttons allows you to skip to lower or higher numbered tracks, or to search backward or forward within a track to locate a specific musical passage.

All of the functions of the ◀◀ and ▶▶ buttons will be fully explained in the appropriate sections of this manual.



Setting The Time, The First Time

IMPORTANT: The first time you connect your new SmartSet® CD clock radio to the AC outlet the internal computer will automatically set the time correctly for the **Eastern Time Zone**, which is the initial default setting. The display will scan for a few seconds and then show the correct Day and Time in the Eastern zone. If you live in the Eastern Time zone, there's nothing else to do. Your clock is set correctly and running.

If you do not live in the Eastern Time zone you must change the default zone display to your own zone. You only do this one time and the SmartSet® will remember the new default zone setting and will always return to that setting after a power interruption

There are 7 time zones programmed into your SmartSet® clock radio as follows:

- ZONE 1 — Atlantic Time
- ZONE 2 — Eastern Time (Default Setting)
- ZONE 3 — Central Time
- ZONE 4 — Mountain Time
- ZONE 5 — Pacific Time
- ZONE 6 — Yukon Time
- ZONE 7 — Hawaiian Time

To change the default time zone display, depress the **TIME ZONE** button. The number **"02"** will appear on the display indicating that the default zone is ZONE 2, Eastern Time.

Hold the **TIME ZONE** button and then press either the **▶▶** or **◀◀** buttons until your own time zone appears on the display, then release the buttons.

The clock display will change to the correct time in the time zone you selected. The clock will always return to the correct time in the zone you selected after every power interruption. If you move to a different time zone, simply change the default zone display to the new zone and the SmartSet® will remember that setting for you.

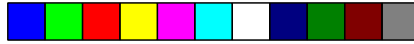

Date Display

To see the correct date at any time, depress the **MONTH/DATE** button. The display changes from time to month and date (MM/DD).

For example, **May 21st** will appear as "5 21".

When you release the **MONTH/DATE** button the display returns to the correct time.



Year Display

To see the correct year, depress the **MONTH/DATE** and **TIME** buttons together, the display changes from time to year.

When you release the **MONTH/DATE** and **TIME** buttons the display returns to the correct time.



Daylight Saving and Leap Year Adjustments

All Daylight Saving and Leap Year adjustments are made automatically by the SmartSet[®] internal computer as follows:

- **Start of Daylight Saving Time:**

At "2:00 AM" on the first Sunday in April, the clock will automatically advance to "3:00 AM".

- **End of Daylight Saving Time:**

At "3:00 AM" on the last Sunday in October, the clock will automatically reset to "2:00 AM".

- **Leap Year:**

At "12:00 Midnight" on February 28th, the calendar display will change to "2 29".

Important Daylight Saving Time Information

As a result of the new Energy Bill that was passed by Congress in August of 2005, Daylight Saving Time is scheduled to be extended starting in 2007. This SmartSet[®] Clock Radio has been programmed to adjust itself automatically for Daylight Saving Time through 2006. We have also provided instructions to allow you to change the Daylight Saving starting and ending dates for 2007 and beyond. You only need to make this adjustment once and then this clock radio will automatically adjust itself for the new Daylight Saving Time through the year 2099.

The instructions for adjusting the Daylight Saving starting and ending dates will be found on a separate addendum sheet included with this Instruction Manual.

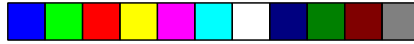

Manual Time Adjustments

Some people like to set their clocks 5 to 10 minutes fast to make sure that they will always be on time. Even though the SmartSet® sets the time by itself, you still have the option of adjusting the time manually if you wish.

To manually adjust the time display depress and hold the **TIME** button, and press either the **▶▶** or **◀◀** buttons to adjust the time display ahead or back as desired. Each press of the **▶▶** or **◀◀** buttons will change the display by one minute. If you hold the **▶▶** or **◀◀** buttons the display will continue to change. The display will change slowly at first, one minute at a time. But if you continue holding the **▶▶** or **◀◀** buttons the display will change rapidly.

Note: If you manually adjust the time, your new setting is entered into the SmartSet® memory. If the power is interrupted, the display will return to your new setting, not the original setting, when the power is restored.

Adjusting The Wake Up Times

Your SmartSet® clock radio has two separate alarms that can be set and used independently. You may use the alarms to wake two people at different times, or you may use one alarm for weekdays and the other for weekend wake up times. The procedure for adjusting the wake up time is the same for both Alarm 1 and Alarm 2.

- 1.) Depress and hold either the **ALM 1** or **ALM 2** setting button. The display will change from the correct time to the Alarm 1 or Alarm 2 wake up time.

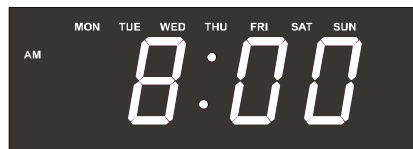

- 2.) While holding the **ALM 1** or **ALM 2** setting button, depress either the **▶▶** or **◀◀** button to move the display ahead or back to your desired wake up time.
- 3.) When the desired wake up time appears on the display, release the **▶▶** or **◀◀** buttons.

Note: Be sure that you have set the wake up time correctly by observing the AM indicator. If the **AM** indicator is 'On' the wake up time is "AM". If the **AM** indicator is 'Off', the wake up time is "PM".

- 4.) When the desired wake up time (AM or PM) appears on the display, release the **ALM 1** or **ALM 2** setting buttons.



Selecting The Alarm Mode

Your SmartSet® clock radio allows you to select from among three different alarm operation modes for either alarm. The alarm modes are:

- **Everyday** – the alarm will turn on all 7 days.
- **Weekdays only** – the alarm will only turn on Monday through Friday;
- **Weekends only** – the alarm will only turn on Saturday and Sunday;

To check the Alarm Mode setting for Alarm 1, depress the **ALM 1** setting button. The display will show the Alarm 1 wake up time and the day of the week indicators will show you the alarm mode which is selected.

- If all 7 indicators are 'On', the Everyday mode is selected.
- If only the Monday through Friday indicators are 'On', the Weekdays only mode is selected.
- If only the Saturday and Sunday indicators are 'On', the Weekends only mode is selected.

To change the Alarm Mode setting for Alarm 1, hold the **ALM 1** setting button and press the **ALARM MODE** button until the day indicators show the desired mode setting, Weekdays only, Weekends only, or Everyday operation.

Release the **ALARM MODE** and **ALM 1** setting buttons and the display will return to the correct time.

Follow the same procedure to select the desired Alarm Mode for Alarm 2 if necessary.

Checking The Wake Up Times And Alarm Mode

Whenever you want to check the wake up time or the alarm mode settings, simply press either the **ALM 1** or **ALM 2** setting buttons. The display will change from correct time to wake up time and the day indicators will show you the alarm mode which is currently selected.

Release the **ALM 1** or **ALM 2** setting buttons to return to correct time.



Listening To The Radio

- 1.) Press the **POWER ON/OFF** button on the top panel. The display will change from time to radio frequency. The first time you turn your unit on the display will show **FM 87.5 MHz**.
- 2.) To switch between the FM and AM bands press the **AM/FM** button. The first time you select the AM band the display will show **AM 520 KHz**.
- 3.) Tune to the desired station with the **▶▶** OR **◀◀** buttons on the top panel as follows:

- **Manual Tuning**

Repeatedly press either the **▶▶** OR **◀◀** button until the display shows the frequency of the desired station.

- **Automatic Tuning**

Depress and hold either the **▶▶** OR **◀◀** button until the display begins to move, then release the button. The tuner searches down or up the band until it finds a strong signal and then stops on that station. Repeat this process until the tuner stops on the desired station.

- 4.) If you tuned to an FM Stereo station the **FM ST** indicator appears in the display.



- 5.) Five seconds after you release the **▶▶** OR **◀◀** button the display automatically changes from radio frequency back to the correct time.
To see the station frequency again, press the **TIME** button. The display will change from time to radio frequency for 5 seconds and then return to the correct time
- 6.) Adjust the **VOLUME** control on the right side of the cabinet to the desired level.
- 7.) When you are finished listening press the **POWER ON/OFF** button to shut the power 'Off'.

Note: *The Tuner remembers the last station that was tuned before the power is switched off and automatically returns to that station when the power is switched on again.*



Presetting Stations In The Tuner Memory

You can store a total of 20 stations, 10 FM and 10AM, in the tuner memory for easy recall at any time.

- Using either the Automatic or Manual Tuning method described above, tune to the first station you wish to store in the tuner memory.



Example: FM **92.5 MHz**

- When the desired frequency appears on the display press the **MEMORY** button once.

"**F 1**" will begin flashing on the display indicating that you can now store your station in FM Preset Memory #1.

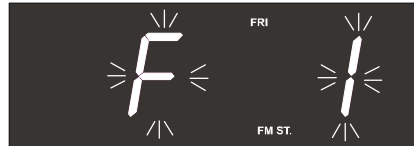

- Press the **MEMORY** button again. The flashing "F 1" disappears and the station frequency returns to the display. This indicates that FM 92.5 is now stored in FM Preset Memory #1.

- Tune to the next station that you wish to store.

Press the **MEMORY** button once, then press the **PRESET +** button to select Preset Memory number 2.

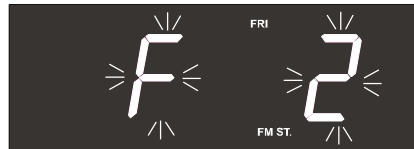

"**F 2**" begins flashing in the display.

- Press the **MEMORY** button once more to enter your desired station in Preset Memory number 2.
- Repeat steps 4 and 5, using the **PRESET -** or **+** buttons to select a different preset memory number each time until you have stored up to 10 FM stations in the memory.
- Press the **AM/FM** button to switch to the AM band and repeat the above procedure to store up to 10 AM stations in the tuner memory.



Notes:

- The FM memories are numbered **F1** through **F10**. The AM memories are numbered **A1** through **A10**.
- After you press the memory button the first time you must select a Preset Memory number and press the **MEMORY** button again within 10 seconds, while the memory number is flashing, or the station will not be memorized.

Recalling Preset Stations

Press the **AM/FM** button to select the desired band.

Press the **PRESET –** or **+** buttons to scroll through the preset stations one by one.

Changing Preset Stations

- 1.) Tune to the new station that you want to store.
- 2.) Press the **MEMORY** button and then press the **PRESET –** or **+** buttons to select the memory number that you wish to change.
- 3.) When the desired Preset Memory number is flashing, press the **MEMORY** button again. The new station is now stored and the previous station is deleted from the memory.



Antenna Information

FM: The FM antenna is built in the AC power cord. You may have to extend and vary the direction of the AC power cord until you find the position that provides the best reception.

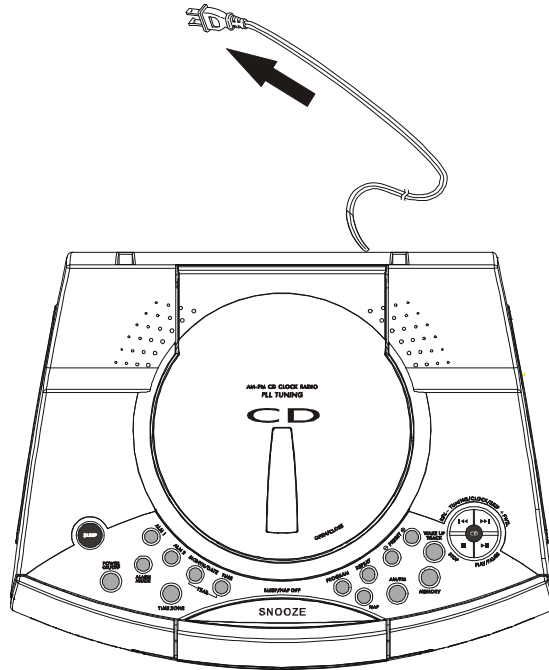

AM: The AM bar antenna is inside the cabinet of the main unit. You may need to change the position of the main unit until you find the position that provides the best reception for your favorite AM stations.

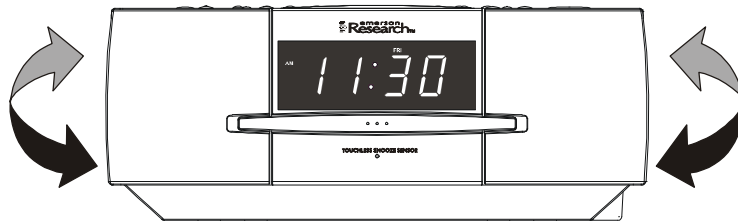

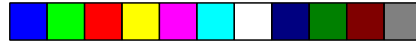

Playing Compact Discs

Important:

This CD player can play normal CDs plus CD Recordable (CD-R) and CD ReWritable (CD-RW) discs. However the playability of CD-R/RW discs may be affected by the type of software that was used in 'ripping' the tracks from the original discs and 'burning' the tracks onto the blank media. Playability may also be affected by the quality and condition of the blank media you use for recording. 100% compatibility cannot be guaranteed. This is not an indication of any problems with your player.

- 1.) Press the **POWER ON/OFF** button to switch the unit 'On'. If you were previously listening to the radio the unit will return to the last station that was tuned before the power was switched off.
- 2.) Press on the CD door in the area marked **OPEN/CLOSE** to open the CD door. When the door opens, if you have not already done so, remove the white "dummy CD" transit protection card and discard it.
- 3.) Place your CD on the center spindle with the printed label side facing up and close the CD door.

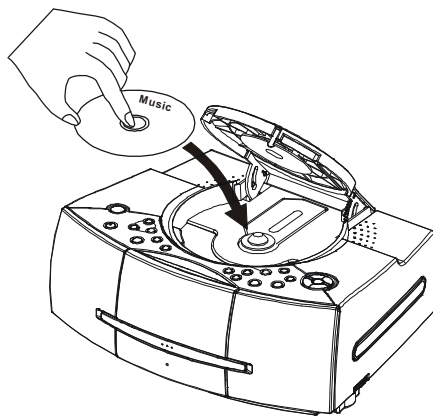

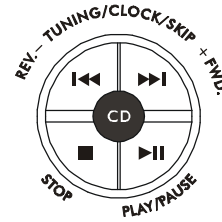
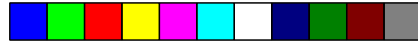

4.) Press the **▶|| PLAY/PAUSE** button on the top panel.

5.) The display briefly shows “**Cd**” and then two dashes “**--**” will appear as the player reads the disc.

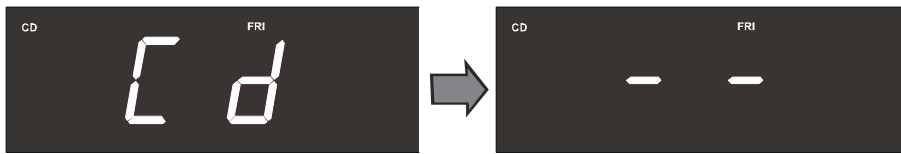

After a few seconds the display will show the total number of tracks on the disc, then playback begins on Track 1.

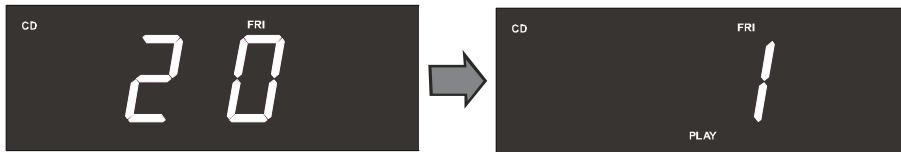

After 5 seconds of playback the display will return to the correct time but the small “**CD**” and “**PLAY**” indicators remain in the display to indicate that a CD is playing.

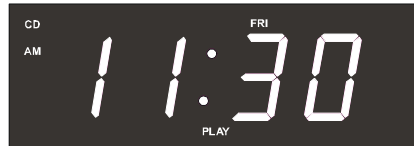

Note: *If your disc is dirty, heavily scratched, or otherwise unreadable the display will continue to show two dashes “--” but playback will not begin.*

6.) Adjust the **VOLUME** control to the desired level.

7.) Playback will continue until the last track has played, then the player stops, the display briefly shows the total number of tracks, then returns to the correct time again. To stop playback before the disc ends press the **■ STOP** button at any time.



- 8.) Press on the CD door in the area marked **OPEN/CLOSE** to open the CD door, remove your disc, and close the door again.
- 9.) Press the **POWER ON/OFF** button to shut the system 'Off'.

Notes:

- *If you shut the power off while a CD is playing and you leave the disc in the player, the disc will start playing from track 1 when you switch the system 'On' again.*
- *To see the track number that is playing press the **TIME** button once. The display will show the track number for 5 seconds and then return to the correct time display.*

Pause Control

To pause CD playback temporarily press the **▶II PLAY/PAUSE** button again. The display will briefly show the track number that is paused and then returns to the correct time.

The sound stops but the disc continues to spin and the **PLAY** indicator flashes.

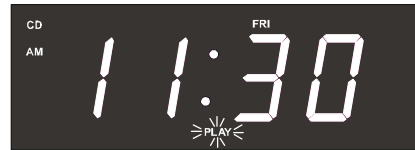

To cancel Pause mode and resume playback press the **▶II PLAY/PAUSE** button again. The sound returns and the **PLAY** indicator stops flashing.

SKIP/Search Controls (◀◀ / ▶▶)

- To skip to higher or lower numbered tracks during playback press the **◀◀** or **▶▶** buttons repeatedly until the desired track number appears in the display. Playback will begin on the desired track.
- To search within a track to locate a specific musical passage depress and hold the **◀◀** or **▶▶** button. The player will search back or forward at high speed. When you hear the desired passage release the **◀◀** or **▶▶** button and normal playback will resume at that point.

Note: *The Volume level is automatically reduced during high-speed music search.*



REPEAT Playback

You can repeat a single track or the entire disc continuously. Repeat playback can be selected while a disc is playing or while the disc is stopped.

Single Track Repeat

Press the **◀▶** or **▶▶** buttons to select the track to be repeated. If necessary, press the **▶| PLAY/PAUSE** button to begin playback, and then press the **REPEAT** button once.

The Repeat indicator **REP** flashes and the selected track will be repeated continuously.

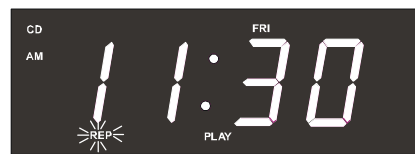

All Tracks Repeat

Press the **REPEAT** button twice.

The Repeat “**REP**” indicator remains ‘On’.

If necessary, press the **▶| PLAY/PAUSE** button to begin playback.

All the tracks on the disc will be repeated continuously.

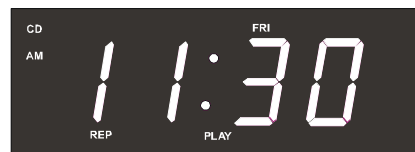

To cancel Repeat Playback press the **REPEAT** button until the Repeat “**REP**” indicator disappears.

Normal playback will resume. Repeat Playback is also canceled by pressing the **■ STOP** button.

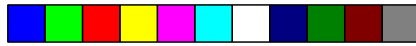

Programmed Playback

Programmed playback allows you to program the player to play up to 20 tracks on a disc in any desired order. You may also program the same track to play multiple times within the same program if desired.

Note: You cannot program the player while the disc is playing. If the disc is playing press the ■ **STOP** button first and then perform the following steps.

- 1.) Press the **PROGRAM** button. The Program "**PROG**" indicator and Track number "**0**" begin flashing in the display.

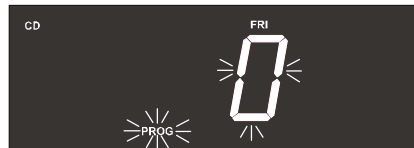

- 2.) Press the **◀** or **▶** buttons to select the first track to be programmed.

Example: Track **7**



- 3.) When track number 7 is flashing in the display press the **PROGRAM** button again to enter track number 7 in program memory number 1.

The track number display returns to "**0**".

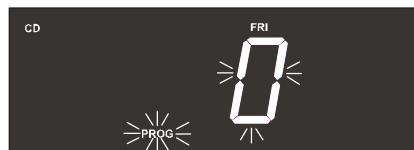

- 4.) Press the **◀** or **▶** buttons to select the next track number to be programmed, and when the desired track number is flashing on the display press the **PROGRAM** button to enter that track in the program memory.

- 5.) Repeat step 4 until you have entered up to 20 tracks in the program memory.

- 6.) Press the **▶||** **PLAY/PAUSE** button to begin programmed playback.

The **PLAY** indicator appears and the Program "**PROG**" indicator continues to flash. The tracks you programmed will be played in the desired order.





7.) After the last programmed track has played the player stops and the **PLAY** and Program "**PROG**" indicators go 'Off'. However the program sequence remains in the memory.

To play the programmed sequence again press the **PROGRAM** button and then press the **▶|| PLAY/PAUSE** button.

If you press the **▶|| PLAY/PAUSE** button without pressing the **PROGRAM** button normal playback will begin on Track 1 as usual.

8.) To cancel the programmed sequence from the memory, press the **■ STOP** button while the player is at programming mode.

The programmed sequence is also canceled if the CD door is opened, the Tuner mode is selected or the power is switched 'Off'.

Programmed Repeat Playback

You can use the Repeat and Programmed Playback features together to continuously repeat a programmed sequence of tracks if desired.

First program the desired tracks and start playback following steps 1 through 6 above.

Then press the **REPEAT** button twice to select All Tracks Repeat. The programmed sequence will be repeated continuously.





Alarm Operation

The dual alarms in this system give you the option of waking to the radio, an electronic buzzer tone, or your favorite track on your favorite CD.

You may also program one or both of the alarms for weekdays only, weekends only, or everyday operation.

Before activating the alarms first check the settings for Alarm 1 and Alarm 2 and adjust if necessary.

Refer to “**Adjusting The Wake Up Times**” and “**Selecting The Alarm Mode**” on pages 14, 15.

Wake To Radio

- 1.) Tune to the station that you want to wake you up, adjust the **VOLUME** control to the desired level, and then shut the system ‘Off’.
- 2.) Slide the **ALARM 1** and/or **ALARM 2** selector switches, located on the left side panel to the “**RADIO**” position.

The **AL 1** and/or **AL 2** indicators will appear in the main display to confirm that the alarms are ‘On’.



- 3.) At the selected wake-up time the radio will turn on to the selected station. It will play for one hour and then shut off automatically and reset itself for the following day.



To shut the radio off sooner you can press either the **POWER ON/OFF** button or the appropriate **ALM 1** or **ALM 2** button on the top panel.

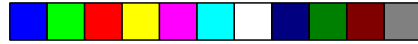

Wake To Buzzer (Crescendo Alarm)

Note: Alarm 1 and Alarm 2 have different buzzer sounds.

Alarm 1 is a “single beep” sound.

Alarm 2 is a “double beep” sound.

You will be able to tell which alarm is going off by the sound that it makes.

- 1.) Slide the **ALARM 1** and/or **ALARM 2** selector switches, located on the left side panel to the “**BUZZER**” position.

The **AL 1** and/or **AL 2** indicators will appear in the main display to confirm that the alarms are ‘On’.

- 2.) At the selected wake up time the electronic buzzer tone alarm will come on. It will start softly and gradually increase in volume to wake you gently.

The buzzer sound will continue for one hour and then shut off automatically and reset itself for the following day.

To shut the buzzer off sooner you can press either the **POWER ON/OFF** button or the appropriate **ALM 1** or **ALM 2** button on the top panel.



Wake To CD

- 1.) Load the desired CD in the player, start playback and adjust the **VOLUME** control to the desired wake up level. Then shut the power 'Off'.
- 2.) Slide the **ALARM 1** and/or **ALARM 2** selector switches, located on the left side panel to the "CD" position. The **AL 1** and/or **AL 2** indicators will appear in the main display to confirm that the alarms are 'On'.
- 3.) If you wish to select a specific track to wake you up, depress and hold the **WAKE UP TRACK** button on the top panel and press the **⏮** or **⏭** buttons to select the desired track.

When the desired track number appears on the display release all the buttons.



Note: The wake-up track number you selected remains in the memory until you change it by selecting a different track.

- 4.) At the selected wake-up time the CD player will turn on to your selected track.

It will play for one hour or until the end of the disc, whichever comes first, and then shut off automatically and reset itself for the following day.



To shut the CD player off sooner you can press the **POWER ON/OFF** button or the appropriate **ALM 1** or **ALM 2** buttons on the top panel.

To Cancel The Alarms

To cancel the alarms completely so they do not come on at all, slide the appropriate **ALARM 1** and/or **ALARM 2** selector switches to the 'OFF' positions.

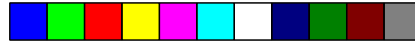

SNOOZE Alarm / “TOUCHLESS” SNOOZE

When the alarms turn on in the morning you can activate the **SNOOZE** control to catch a few minutes extra sleep. The Snooze function stops the alarm for 9 minutes and then turns the alarm ‘On’ again.

There are two ways to activate the Snooze control: by touching the **SNOOZE** button on the top panel; or by placing your hand in front of the **SNOOZE** Sensor on the front panel.

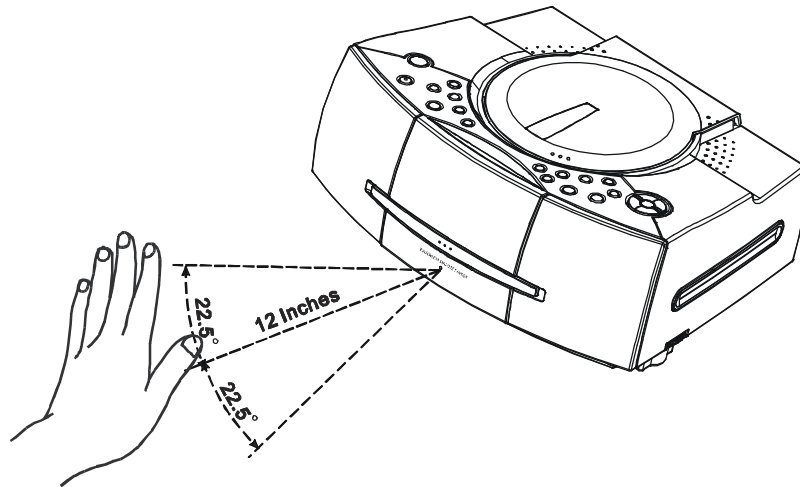

When the Snooze function has been activated the appropriate **AL 1** or **AL 2** indicator flashes in the display.



Note: *The Snooze Sensor detects the difference in temperature between your hand and the ambient room temperature and it is quite accurate.*

*However in the unusual condition where there is almost no difference between your hand temperature and the room temperature the touchless snooze function may not operate. In this case please press the **SNOOZE** button on the top panel.*





SLEEP Timer

The Sleep Timer allows you to operate the radio or CD player for up to 99 minutes while you are falling asleep and then shuts the power off automatically.

- 1.) Turn the system 'On' and operate the radio or CD player as usual.

Adjust the **VOLUME** control to the desired level for falling asleep, but remember that the level you set for falling asleep is that same level that you will hear in the morning if you are waking to radio or CD.

- 2.) Press the **SLEEP** button on the top panel.

The display will show "L:30" and the **SLP** (Sleep) indicator will appear.



The radio or CD player will operate for 30 minutes and then shut off automatically.

- 3.) To change the amount of Sleep time depress and hold the **SLEEP** button and press the **◀** or **▶** buttons to decrease or increase the amount of sleep time from 2 minutes to 99 minutes.

Note: When you change the Sleep timer from the original 30-minute default setting your new setting becomes the new default setting.

For example if you change the Sleep timer setting from 30 minutes to 45 minutes, 45 minutes becomes the new default Sleep timer setting until you change it again.

- 4.) When the Sleep timer counts down to "00" the power shuts off automatically.

Note: If you set the Sleep timer for 60 minutes but you are playing a CD that is only 45 minutes long, the music will stop after 45 minutes but the power will remain 'On' until the Sleep timer counts down to "00".

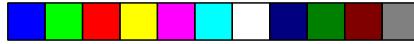

NAP Timer (Buzzer Alarm Only)

The Nap timer function will wake you to the buzzer alarm after a nap of up to 99 minutes without the need to change your regular Alarm 1 or Alarm 2 settings.

- 1.) If the system is playing, shut the power 'Off'.
- 2.) Press the **NAP** button on the top panel.

The display will briefly show "n:30" and the **NAP** indicator appears.



After 30 minutes the crescendo buzzer alarm will turn on to wake you up.

- 3.) To change the amount of naptime depress and hold the **NAP** button and press the **◀** or **▶** buttons to decrease or increase the amount of naptime from 2 minutes to 99 minutes.

Note: When you change the Nap timer from the original 30-minute default setting your new setting becomes the new default setting.

For example if you change the Nap timer setting from 30 minutes to 45 minutes, 45 minutes becomes the new default Nap timer setting until you change it again.

- To cancel Nap Timer, press the **SNOOZE** button.

DIMMER Control

The display dimmer control was set to the **HI** (High) position at our factory.

If you find the display to be too bright for sleeping, slide the **DIMMER** switch to the **LO** (Low) position.

PHONES (Stereo Headphone) Jack

This system includes a stereo headphone jack for private listening without disturbing others. The headphone jack is located on the right side of the cabinet. The built in speakers automatically shut off when headphones are connected to the headphone jack.

Important: Before connecting your headphones, set the **VOLUME** control to a low level. Then connect your headphones, put them on and gradually increase the volume to a comfortable listening level. Remember that CDs can often contain very loud passages as well as softer passages. It is a good idea to adjust the listening level during a louder passage so that you are not surprised by a sudden, uncomfortable increase in the headphone sound.

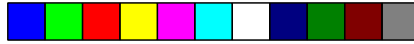

Changing The Lithium Battery

Like all batteries, eventually the built in lithium battery will need to be replaced. A number of factors, such as, the length of time between the date the radio was manufactured and the date you plugged it in for the first time determine the amount of time before replacement.

During this initial storage period, the lithium battery is supplying power to the SmartSet® computer memory. Once you plug the radio in, your household outlet supplies the power, and the battery is not being used.

A fresh lithium battery can supply power to the SmartSet® computer for at least 3 years even if it is never connected to an AC power supply. If your radio was connected to your AC supply within a few months after it was manufactured, and you experience only the normal, nuisance type, short duration power interruptions, your battery may last for up to 5 years or even longer.

When the battery power drops below a certain level, the “ **LOW**” indicator will ‘flash’. When you see this indicator, you should change the battery as soon as it is convenient for you to do so. To change the battery proceed as follows:

- 1.) Purchase a replacement 3V lithium battery wherever batteries are sold. The battery type is **CR2430** or equivalent.
- 2.) Remove the battery from its package so it is ready to install.

IMPORTANT: Leave the radio power cord connected to your AC outlet. This will provide power to the SmartSet® computer memory while the original lithium battery is removed.

- 3.) Turn the radio upside down and use a small screwdriver to remove the two screws securing the battery holder to the cabinet.

BE CAREFUL NOT TO LOSE THIS SMALL SCREWS!



- 4.) Remove the original battery from the holder and insert the new battery into the holder the same way, observing the positive (+) direction.

Slide the holder with the new battery back into the slot in the cabinet.

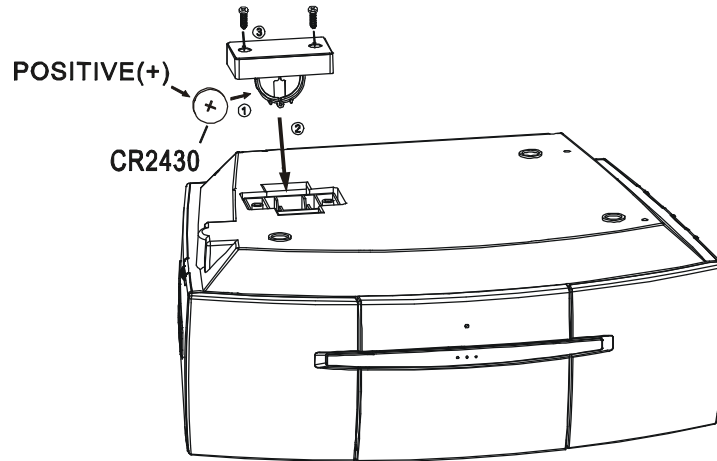

- 5.) Replace the screws that secure the battery holder in the cabinet.
- 6.) Turn the radio right side up and confirm that the “LOW” indicator is no longer flashing or ‘Off’ if you also have installed a 9V battery.
- 7.) Save these instructions. You’ll have to do this again five to eight years from now!

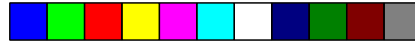

Resetting The Clock After A Total Memory Loss

If you do not change the built in lithium battery within a reasonable period of time after you see the flashing “ **LOW**” warning indicator, the lithium battery may become exhausted and will no longer be able to supply back up power to the SmartSet® internal computer.

If the unit is disconnected from the AC outlet after the battery is exhausted, or if a power interruption occurs, the SmartSet® memory will be lost and the clock will need to be reset when the power is restored. Be sure to install a fresh lithium battery before you reset the clock, otherwise the clock will need to be reset each time the power is interrupted.

If the lithium battery is exhausted and you experience an interruption in the AC power supply, the clock will reset itself to its initial default setting when the power is restored.

The initial default setting is “**AM 12:00, Saturday, January 1st (1 01), 2005**”.

If you notice that the time on your SmartSet® clock radio is completely incorrect, and the day indicator is also wrong, press the **MONTH/DATE** button to see the date. If the date display is showing “**1 01**” (January 1st), you probably experienced a total memory loss.

To reset the clock after a total memory loss, proceed as follows:

- 1.) Follow the instructions on pages 32-33 and install a new **CR2430** lithium battery in the battery compartment.
- 2.) Connect the radio to your AC outlet and let the clock set itself.
- 3.) Depress the **MONTH/DATE** and **TIME** buttons together. The display will change from ‘Time’ to ‘Year’.

While holding the **MONTH/DATE** and **TIME** buttons, press the **▶▶** button to set the display to the correct year if necessary, then release the buttons.

- 4.) Depress the **MONTH/DATE** button. The display will change from ‘Time’ to ‘Month/Date’ (mm/dd).

While holding the **MONTH/DATE** button, press the **▶▶** button to set the display to the correct Month and Date. The Day indicator will change automatically as you adjust the Month/Date settings. When the correct month and date appear on the display, release the buttons.



- 5.) Depress the **TIME** button and the **▶▶** button to set the display to the correct time. Be sure to confirm that you have set the time correctly to 'AM' or 'PM' by observing the **AM** indicator.

- 6.) After you set the time, reconfirm that the Day, and Month/Date displays are still correct. Make final adjustments if necessary.

The SmartSet® clock memory is now reset and the new lithium battery will maintain it for the next 5 to 8 years, depending on the number and duration of the power outages you experience.

Important Note:

After resetting the clock, don't forget to reset your wake up times, and alarm mode settings, and sleep timer settings as well.





CARE AND MAINTENANCE

Compact Disc Care

- To remove a disc from its storage case, press down on the center of the case and lift the disc out, holding it carefully by the edges.

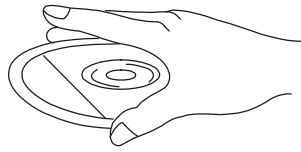
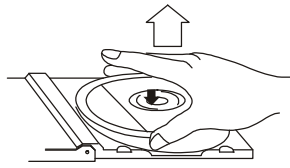

- Fingerprints and dust should be carefully wiped off the disc's recorded surface with a soft cloth. Unlike conventional records, compact discs have no grooves to collect dust and microscopic debris, so gently wiping with a soft cloth should remove most particles. Wipe in a straight line from the inside to the outside of the disc. Small dust particles and light stains will have absolutely no effect on reproduction quality.

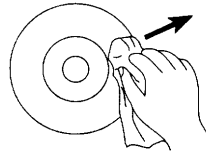
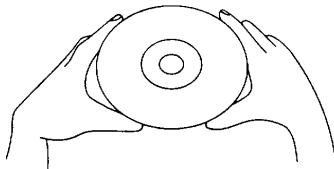

- Clean the disc periodically with a soft, lint-free, dry cloth. Never use detergents or abrasive cleaners to clean the disc. If necessary, use a CD cleaning kit.
- Never write on or affix labels to the surface of compact discs.



Care Of The Cabinet

If the cabinet becomes dusty wipe it with a soft dry dust cloth. Do not use any wax, polish sprays, or abrasive cleaners on the cabinet.

Caution

Never allow any water or other liquids to get inside the unit while cleaning.

Lithium Battery Precautions

- *Dispose of the old battery properly. Do not leave it lying around where a young child or pet could play with, or swallow it. If the battery is swallowed, contact a physician immediately.*
- *Battery may explode if mistreated. Do not attempt to recharge it or disassemble it. Do not dispose of the old battery in a fire.*



	TO FIND THE LOCATION AND PHONE NUMBER OF YOUR NEAREST SERVICE CENTER PERMITTED TO PERFORM WARRANTY...
CALL TOLL FREE: 1-800-695-0098	
FOR ADDITIONAL SET-UP OR OPERATING ASSISTANCE PLEASE CALL: 1-800-898-9020	
FOR CUSTOMER SERVICE, PLEASE WRITE TO: Emerson Radio Corp., Consumer Affairs Dept., 5101 Statesman Drive, Irving, TX 75063.	





LIMITED WARRANTY

Emerson Radio Corp. warrants manufacturing defects in original material, including original parts and workmanship, under normal use and conditions, for a period of ninety (90) days from the date of original purchase in the U.S. With your dated proof of purchase, we will provide repair service at no charge for labor and parts at an authorized Depot Repair Facility, or replace the product in our discretion. For repair or replacement, pack your unit in a padded box, enclose your check or money order payable to Emerson Radio Corp. in the amount of \$9.00 (not required by California residents) to cover shipping and handling costs, and enclose a copy of your proof of purchase. Send your unit to:

Emerson Radio Corp.,
5101 Statesman Drive,
Irving, TX 75063.

This warranty does not cover damage from negligence, misuse, abuse, accident, failure to follow operating instructions, commercial use, rental, repairs by an unauthorized facility, or products purchased, used, serviced or damaged outside of the United States.

THIS WARRANTY GIVES YOU SPECIFIC LEGAL RIGHTS, AND YOU MAY ALSO HAVE OTHER RIGHTS WHICH VARY FROM STATE TO STATE.

AU898M

The Serial Number of your unit is located on a label on the bottom cabinet. Please take a moment to locate the Serial Number of your unit and write it in the space provided below. You may be asked to provide this number when calling to request customer service.

Model Number: CKD5809

Serial Number: _____



 emerson
Research™



EMERSON
Part No. 16-2969
603-04

Printed in China



CKD5809_030706.p65

39



7/3/2006, 14:57

